

APPLICATION INSTRUCTIONS

FOR THE

NATURE MOTOR SENSORY PATHWAY PREMIUM RESUSABLE STENCIL PACKAGE

Product Number: SP-NP-015

Completely read "General Instructions." Prepare surfaces as recommended before painting.

This document contains Application Instructions for the following Reusable Stencils included in the **NATURE MOTOR SENSORY PATHWAY PREMIUM RESUSABLE STENCIL PACKAGE**:

1. MOTOR SENSORY ACTIVITY STATIONS: Product Number: 19-1W-091
2. NATURE ACTIVITY CIRCUIT: Product Number: 13-5W-043
3. DAISY HOPSCOTCH: Product Number: 12-2W-03

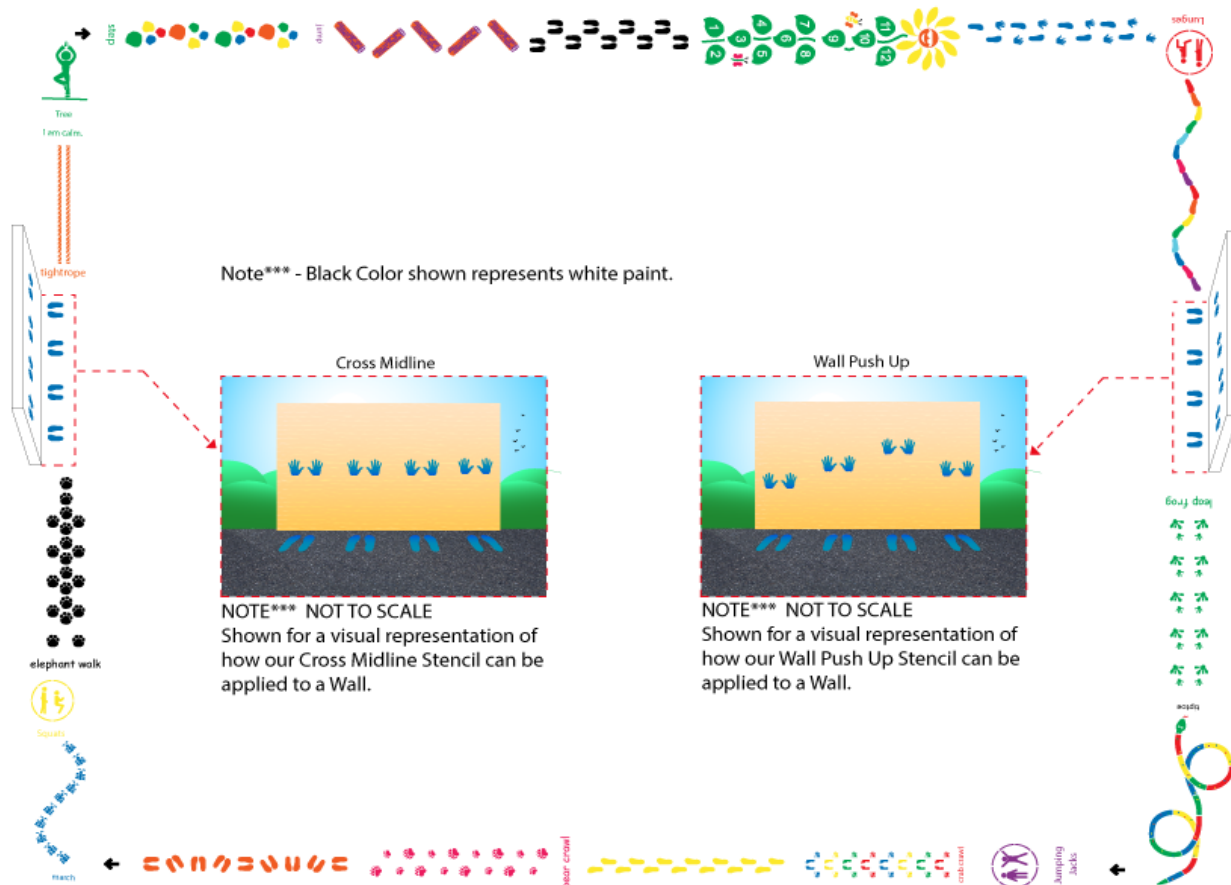

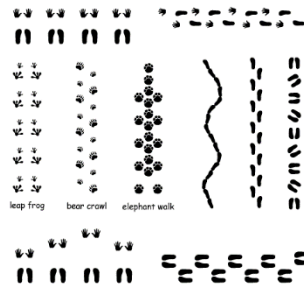
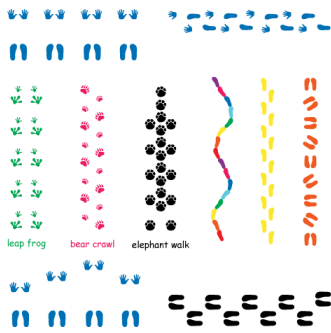

WHITE IS SHOWN AS BLACK HERE

APPLICATION INSTRUCTIONS FOR THE MOTORY SENSORY ACTIVITY STATIONS:

Product Number: 19-1W-091

SIZE: linear/ circuit layout approximately 2-3 feet wide x 100 feet long.

ESTIMATED PAINT TIME: 2-4 people for 2-3 hours.

READ FIRST: Completely read "General Instructions" attached to this document. Prepare surfaces as recommended before painting.

- Place stencils as shown below. Paint and repeat 1-2 more times to achieve desired vividness, drying after each application. Remove the STENCILS. Once paint is completely dry, align remaining stencils. Paint and repeat 1-2 more times to achieve desired vividness, drying after each application Repeat to create patterns desired.

Hand and Foot Print Cross Midline

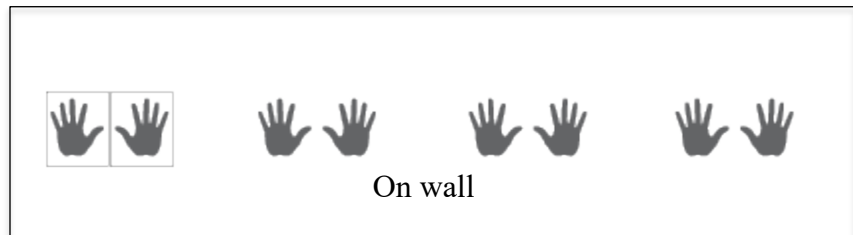

On ground/ floor

Wall Pushup

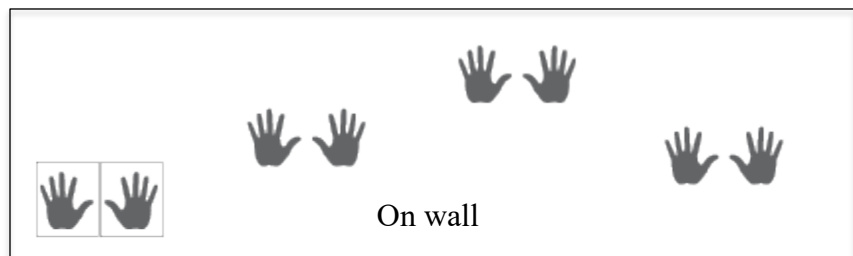

On ground/ floor

Foot Print Crossing Midline



Foot Prints Heel to Toe



Foot Print Spin



Foot Prints Side Step



Foot Prints Ladder



Bear Crawl Set Step 1



Bear Crawl Set Step 2



Bear Crawl Set Step 3



Bear Print Step 1



Bear Print Step 2



Bear Print Step 3



Elephant Walk Set Step 1



Elephant Walk Set Step 2

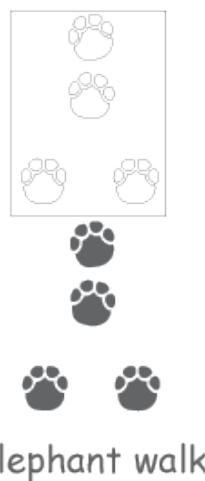

Elephant Walk Set Step 3



Elephant Print Set Step 1



Elephant Print Set Step 2



Elephant Print Set Step 3



Leap Frog Set Step 1



Leap Frog Set Step 2



Leap Frog Set Step 3



Frog Prints Step 1



Frog Prints Step 2

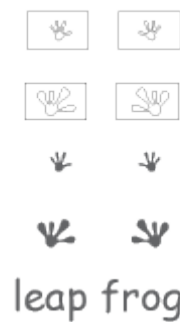

Frog Prints Step 3



Arrow



2. Allow all paint to dry for a minimum of 24 hours.

APPLICATION INSTRUCTIONS

FOR THE

NATURE ACTIVITY CIRCUIT

Product Number: 13-5W-043

SIZE: varies from 24-45 feet.

ESTIMATED PAINT TIME: 2-6 people for 2-6 hours.

READ FIRST: Completely read "General Instructions". Prepare surfaces as recommended before painting.

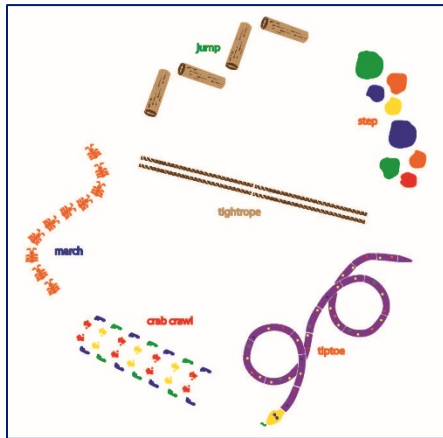
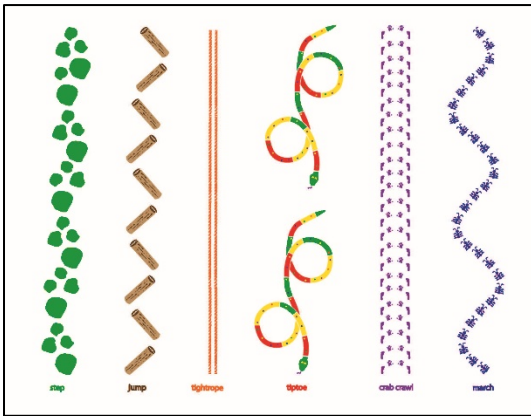

Layout B

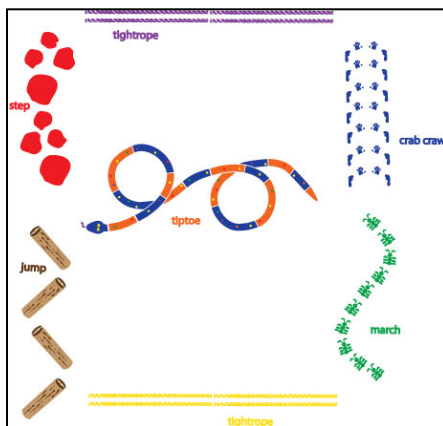

Layout C

This stencil can be applied a number of different ways. Enclosed are just a few methods. Print out only what you need.

It is recommended that the snake stencil be chalked out as noted in the instructions below.

LAYOUT A



step

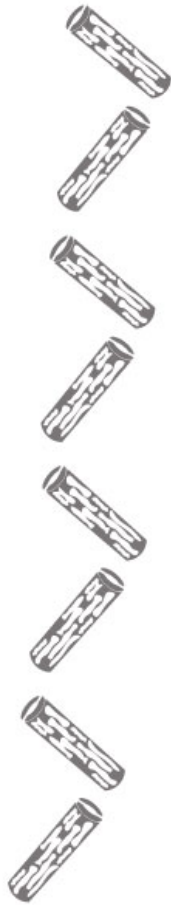

jump



tightrope



tiptoe



crab crawl



march

LAYOUT A

This layout can be applied in a number of ways, including one at a time or laying out the stencils at once. The following is one of many ways to complete this layout. Be sure to apply more than one coat to achieve desired vividness, drying after each application

1. Locate start line using chalk line which should be approximately 45 feet long. Align word stencils along chalk line as indicated below, spaced evenly apart. Paint each word stencil, let dry and remove.



2. Align larger stencils over painted words on pavement as shown below. Note that the snake stencil is wider and is shifted to the left of the "tip-toe" word, aligned so that the head is lined up with the first letter "t". With the exception of the snake stencil, paint each, drying after each application and then remove.

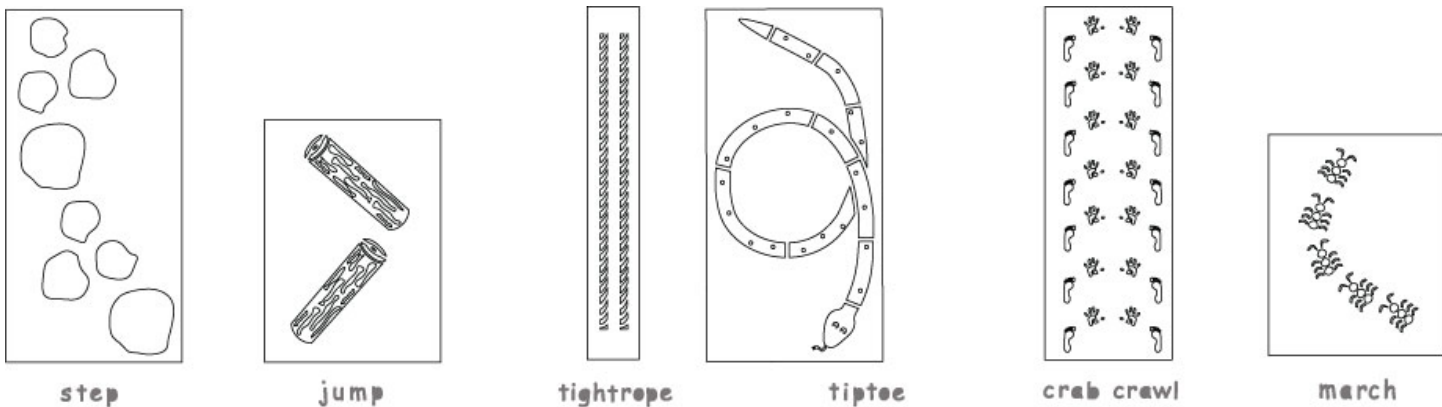

3. For the snake stencil, you may want to chalk out the snake stencil before painting to ensure it loops back properly. With chalk, mark the head and the section after the loop shown as point "A". See detailed insert below. Paint from the head up ONLY to the section after the loop at point A. Do not paint to the tail yet. Let dry and remove stencil.

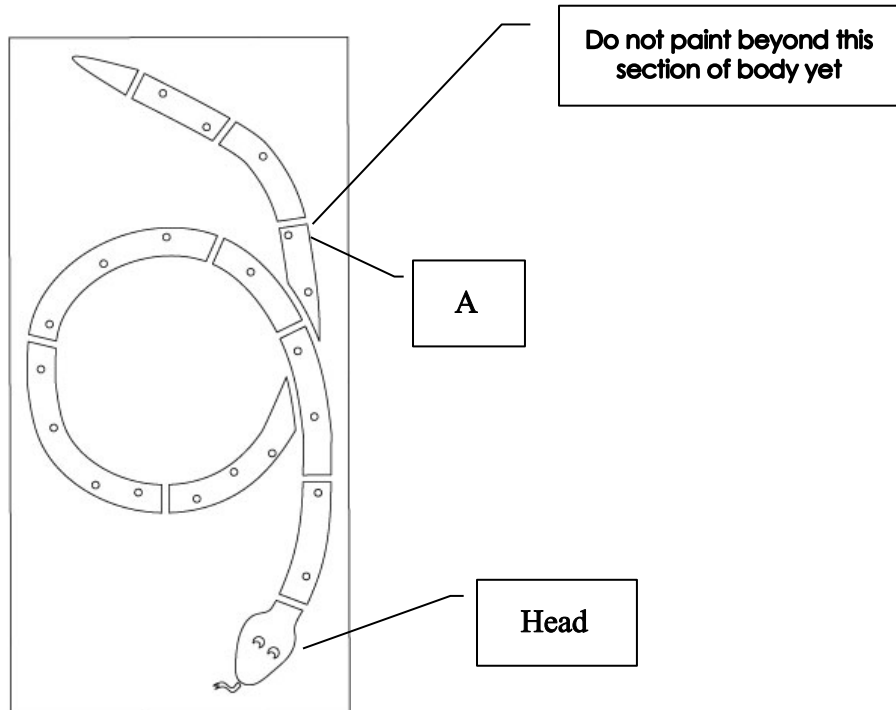

4. The painted pavement should appear as shown below:

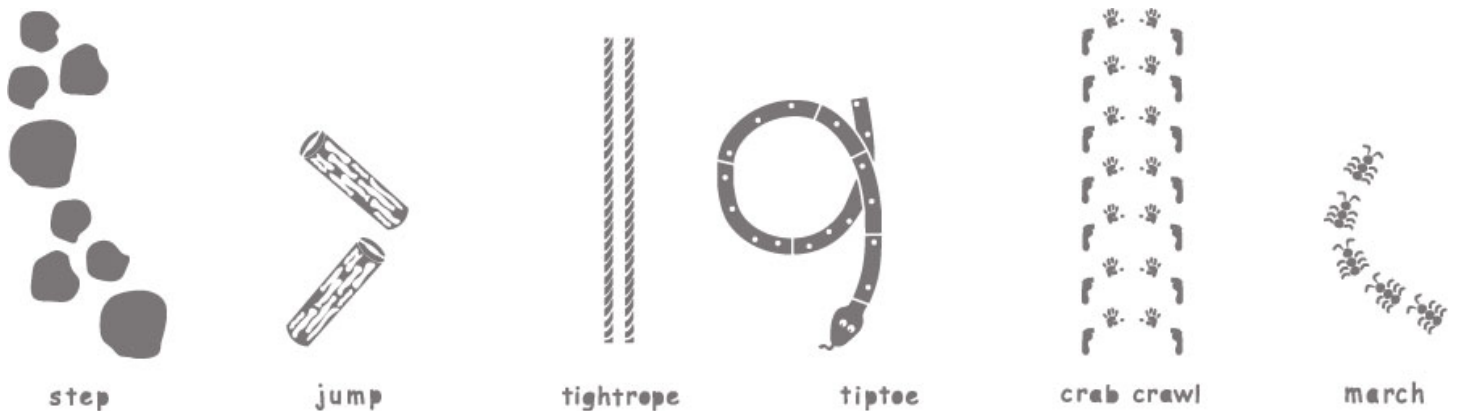

- Once dry, re-align stencils as shown below. Take dried snake stencil, flip it over and align body section to painted snake body on the pavement, as shown below. Align the stencil section just below the head to the painted body end to form a double loop as shown in the enlarged insert.

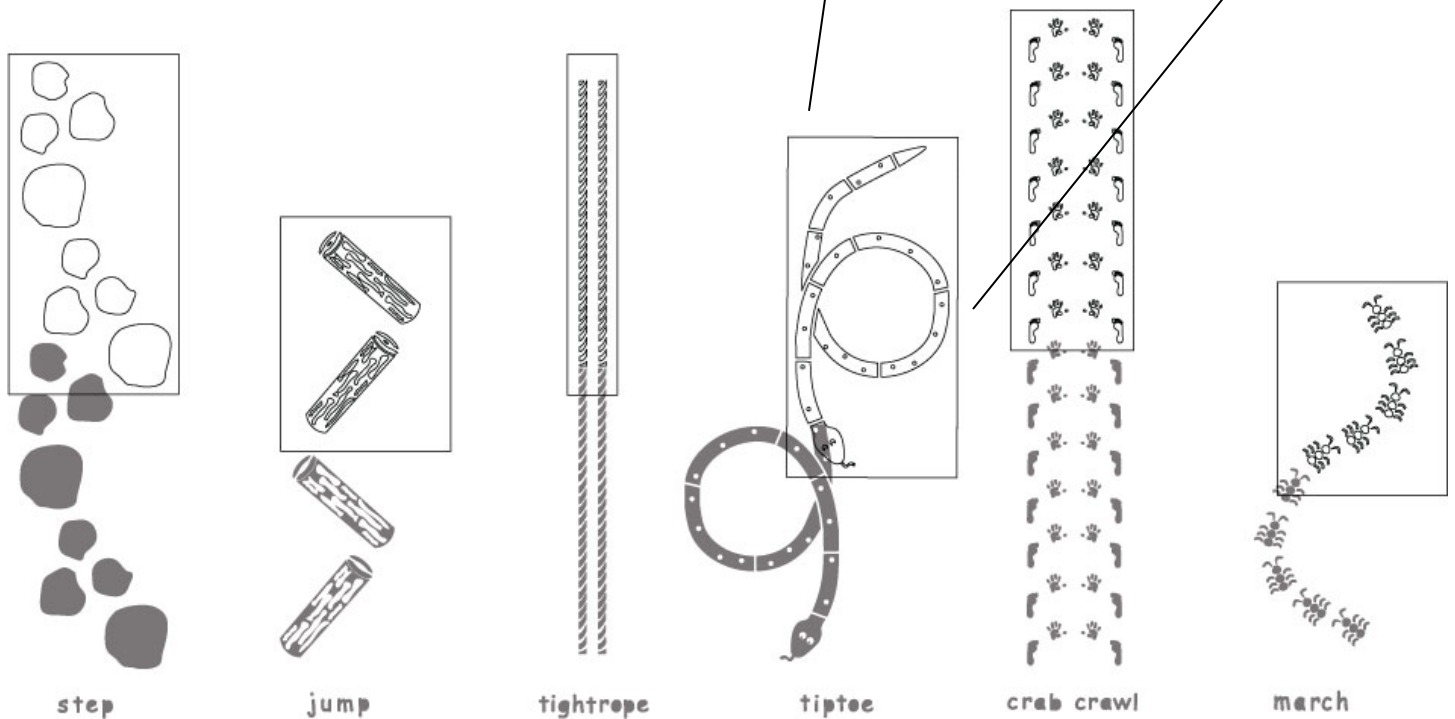

6. Once dry, continue to re-align stencils, following directions above, and paint as shown below any number of times to reach desired length.

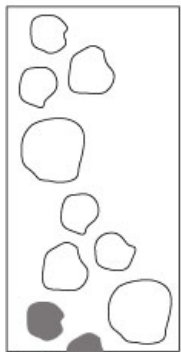

step

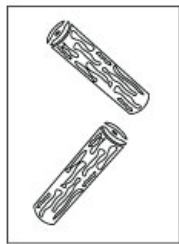

jump

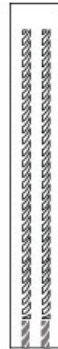

tightrope

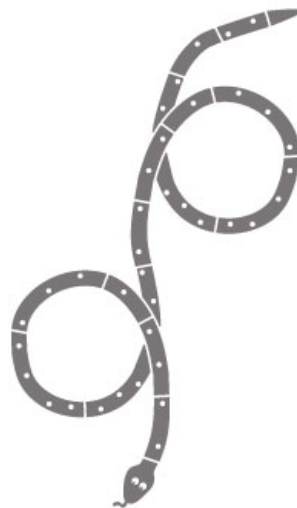
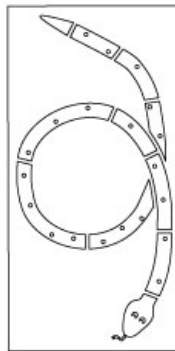

tiptoe

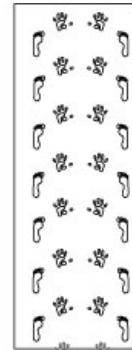

crab crawl

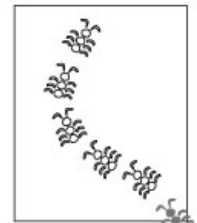

march

7. Allow to completely dry for at least 24 hours before use.

LAYOUT B

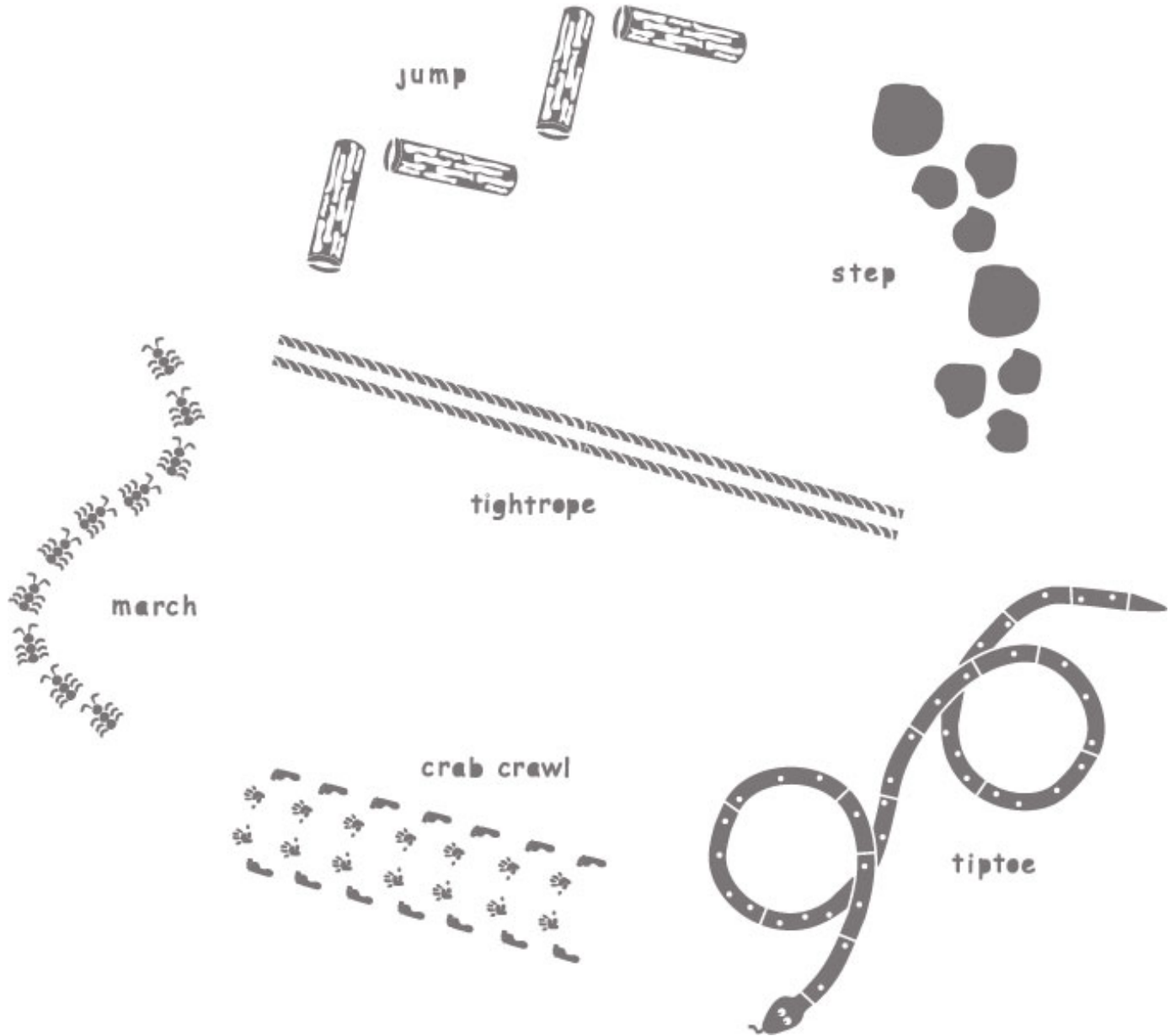

LAYOUT B

This layout can be applied in a number of ways, including one at a time or laying out the stencils at once. The following is one of many ways to complete this layout. Be sure to apply more than one coat to achieve desired vividness, drying after each application.

- Starting with the rope stencil, place at center of area to be painted on a slight angle as shown below left. Paint, let dry and remove stencil. Once pavement and stencil is dry, place the rope stencil next to the painted rope on the pavement as shown below right, and paint. Let dry and remove.

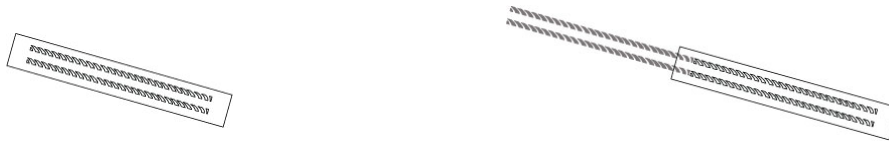

- Take stepping stones stencil and place to side of rope as shown below left. Paint, let dry and remove stencil. Take wood log stencil and place to other side of rope stencil, on a slight angle, as shown below right. Paint, let dry and remove stencil.

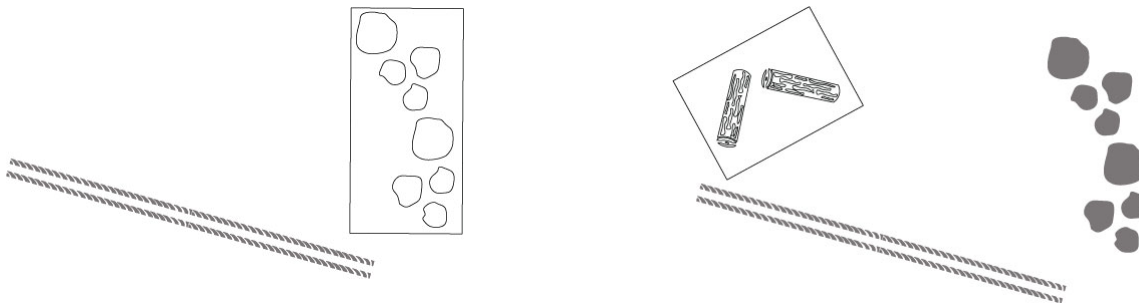

- Take wood log stencil and place next to painted wood logs on the pavement as shown below left. Paint, let dry and remove stencil. Results should appear as below right.

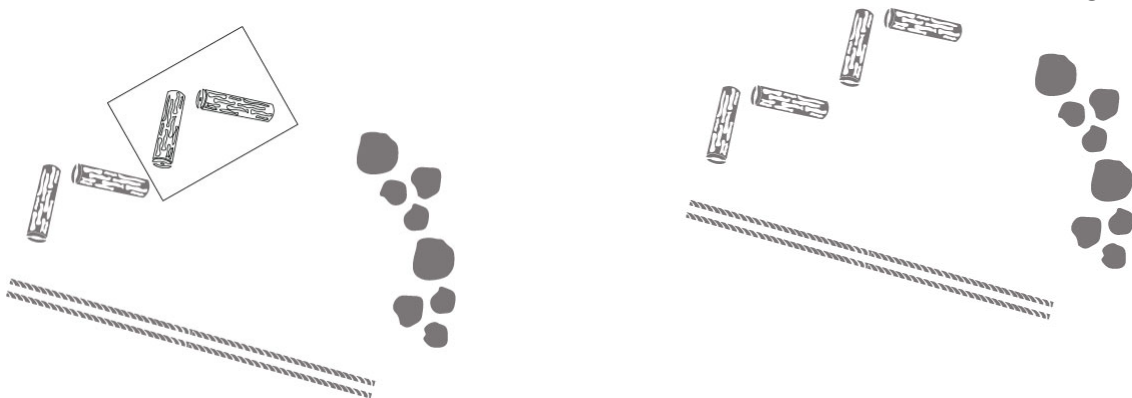

4. Take ants stencil and place on a slight angle next to the painted ropes on the pavement, as shown below left. Paint, let dry and remove stencil. Take dried ants stencil, flip it over and align at the bottom of the painted ants on the pavement, as shown below right. Paint, let dry and remove stencil.

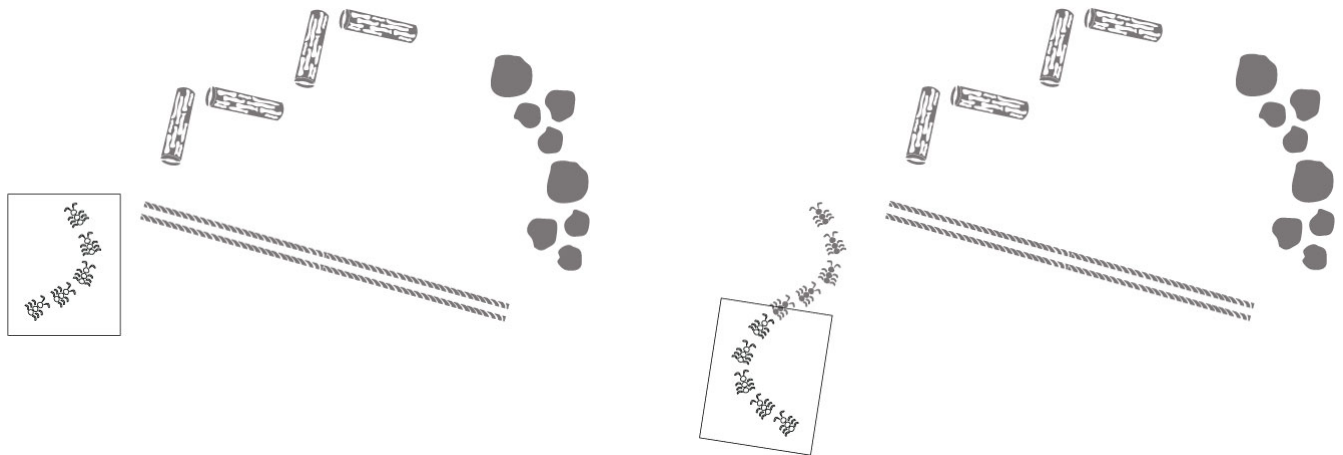

5. Take hands and feet stencil and place somewhat parallel to the painted rope stencil as shown below left. Paint, let dry and remove stencil. The painted games should appear similar to what is shown below right.

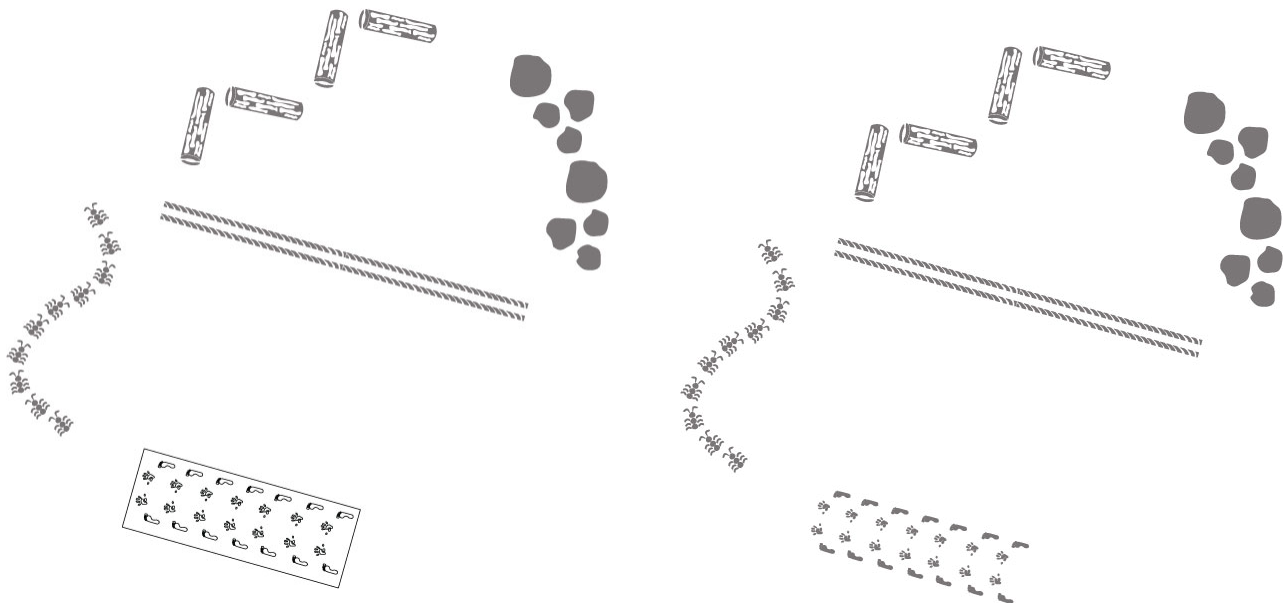

6. The next step involves the snake stencil, which you may want to chalk out before painting to ensure it loops back properly. Take the snake stencil and place it as shown below left, on a slight angle, but perpendicular to the painted rope stencil. With chalk, mark the head and the section after the loop shown as point "A". See detailed insert below right. Paint from the head up ONLY to the section after the loop at point A. Do not paint to the tail yet. Let dry and remove stencil.

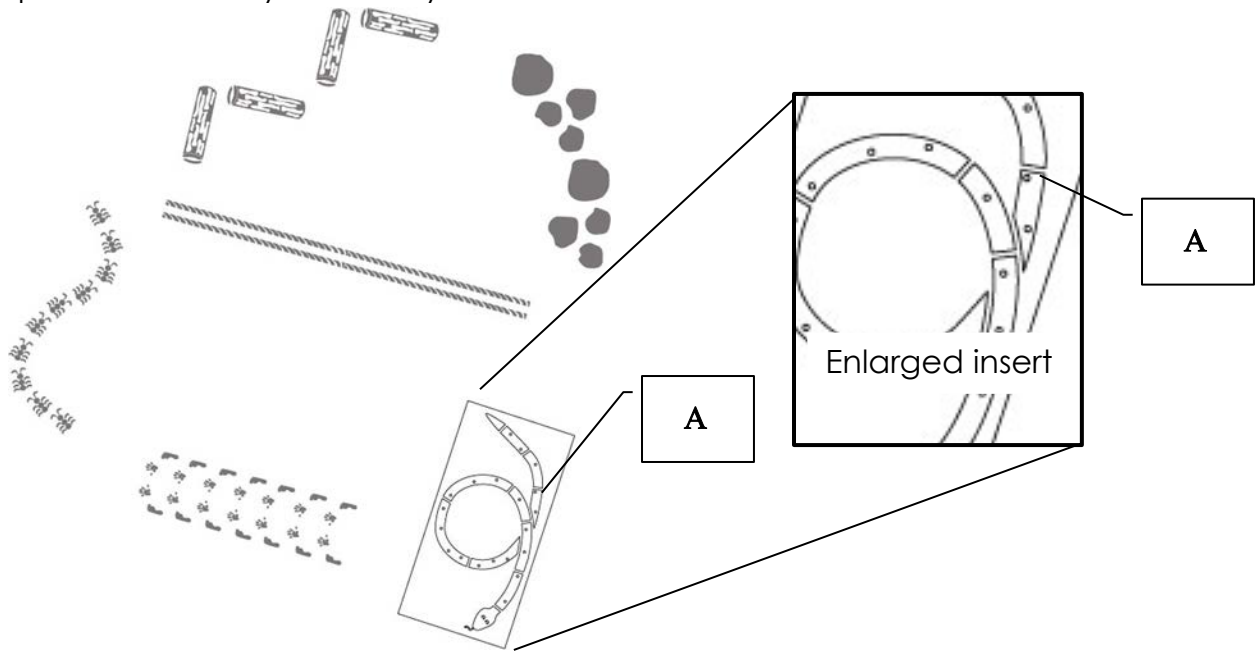

7. The pavement in the area of the snake should appear as below left. Take dried snake stencil, flip it over and align body to painted snake body on the pavement, as shown below center and right insert. (Align the stencil section just below the head to the painted body end to form a double loop.)

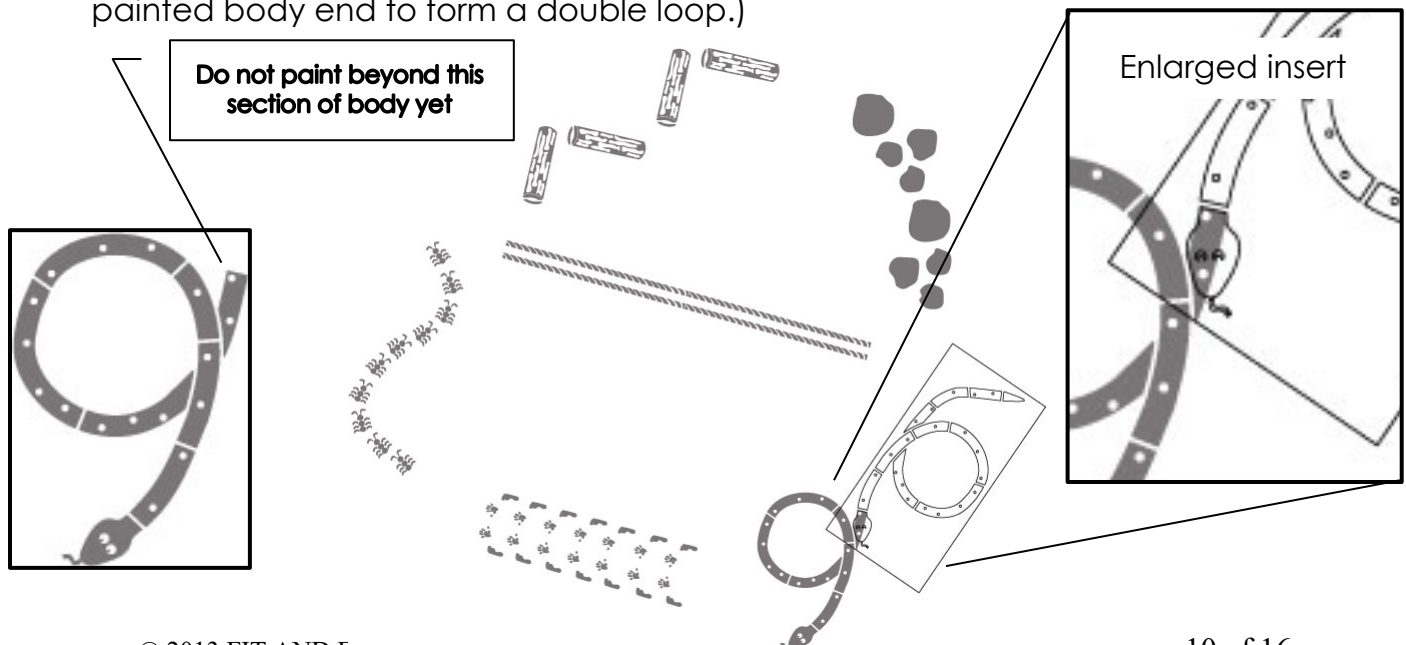

8. Remove snake stencil. The painted games on the pavement should appear as below.

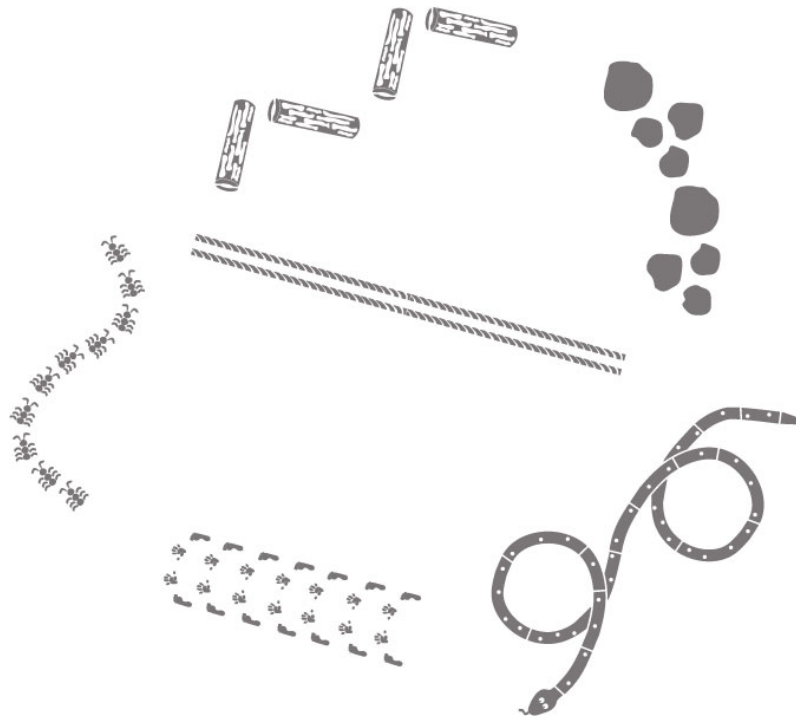

9. Take the word stencils and align as shown below left. Paint, let dry and remove stencils. The layout is complete as shown below right.

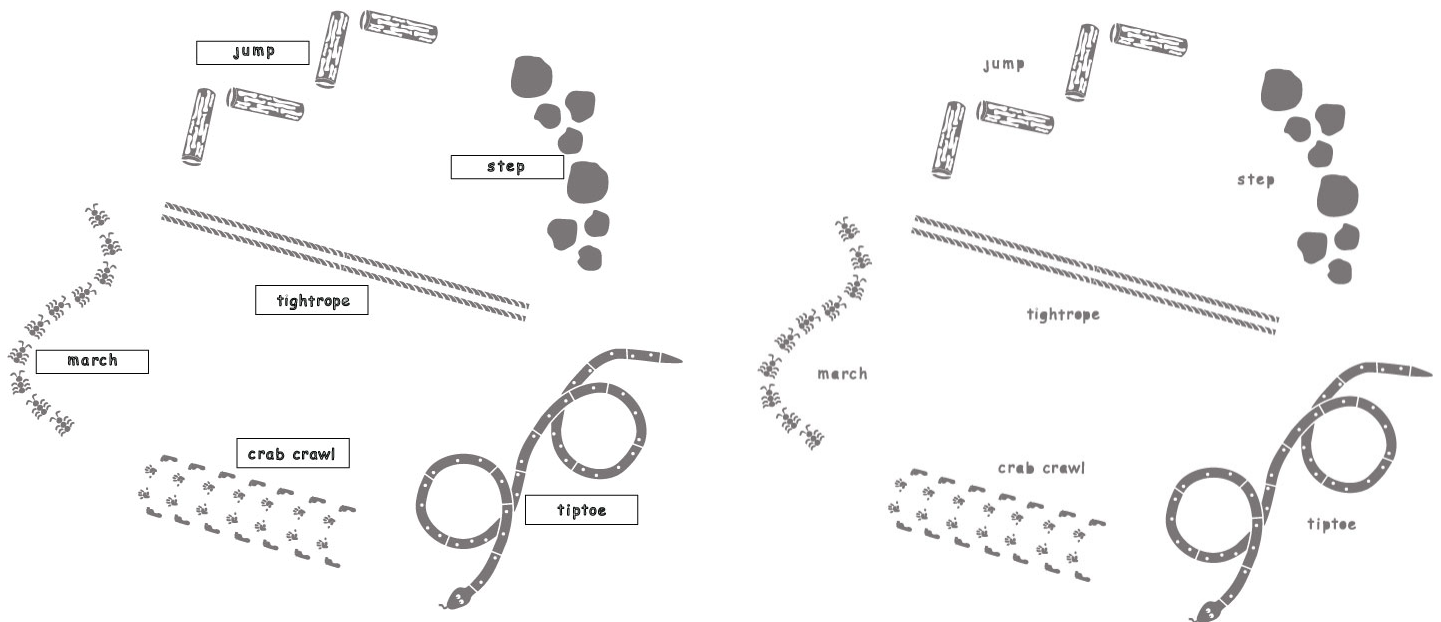

10. Allow to completely dry for at least 24 hours before use.

LAYOUT C

tightrope



step



crab crawl

tiptoe

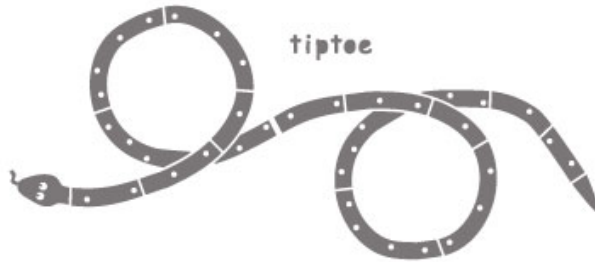

jump



march



tightrope

LAYOUT B

This layout can be applied in a number of ways, including one at a time or laying out the stencils at once. The following is one of many ways to complete this layout. Be sure to apply more than one coat to achieve desired vividness, drying after each application.

- Starting with the rope stencil, below left, place at top part of area to be painted and make sure it is straight. Paint, let dry and remove stencil. Once pavement and stencil is dry, place the rope stencil next to the painted rope on the pavement as shown below right, and paint. Let dry and remove.



- Working clockwise, to the right, place the hands and feet stencil to the side of the rope as shown below left, in a perpendicular position. Paint, let dry and remove stencil. Once pavement and stencil is dry, place the stepping stones stencil next to the other side of the painted rope on the pavement as shown below right, and paint. Let dry and remove.

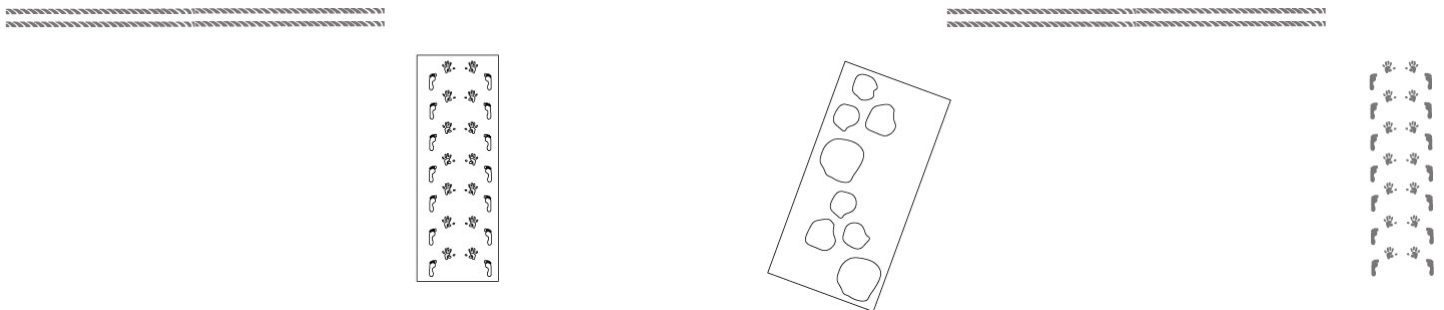

- The next step involves the snake stencil, which you may want to chalk out before painting to ensure it loops back properly. Take the snake stencil and place it as shown below, on a slight angle. With chalk, mark the head and the section after the loop shown as point "A". See detailed insert next page.

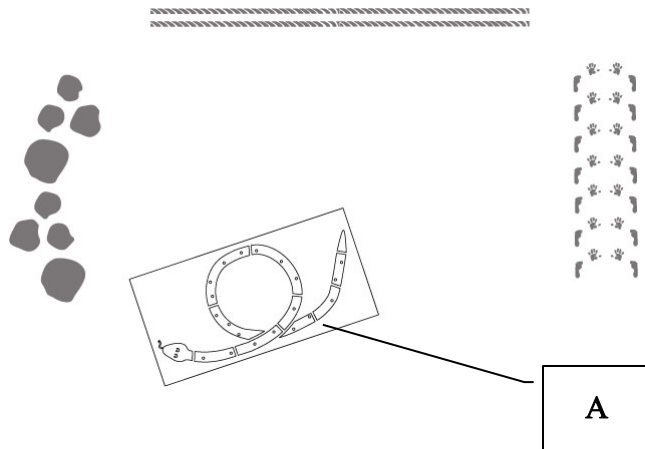

4. Paint from the head up ONLY to the section after the loop at point A as shown below left, enlarged insert. Do not paint to the tail yet. Let dry and remove stencil. The painted pavement should appear as shown below right.

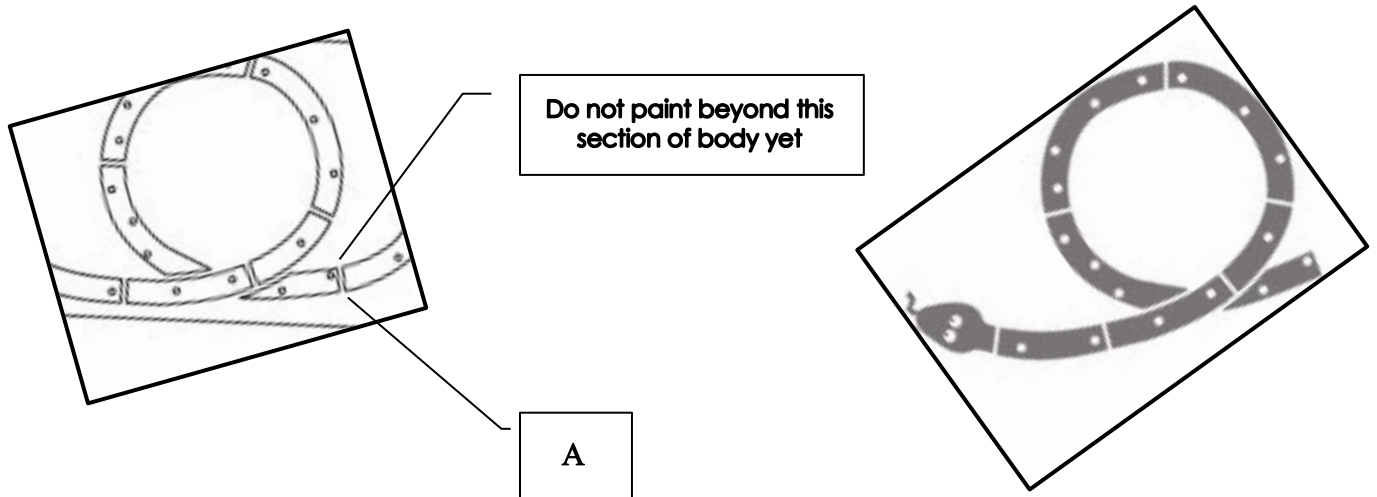

5. Take dried snake stencil, flip it over and align body to painted snake body on the pavement, as shown below left and enlarged detail below right. (Align the stencil section just below the head to the painted body end to form a double loop.)

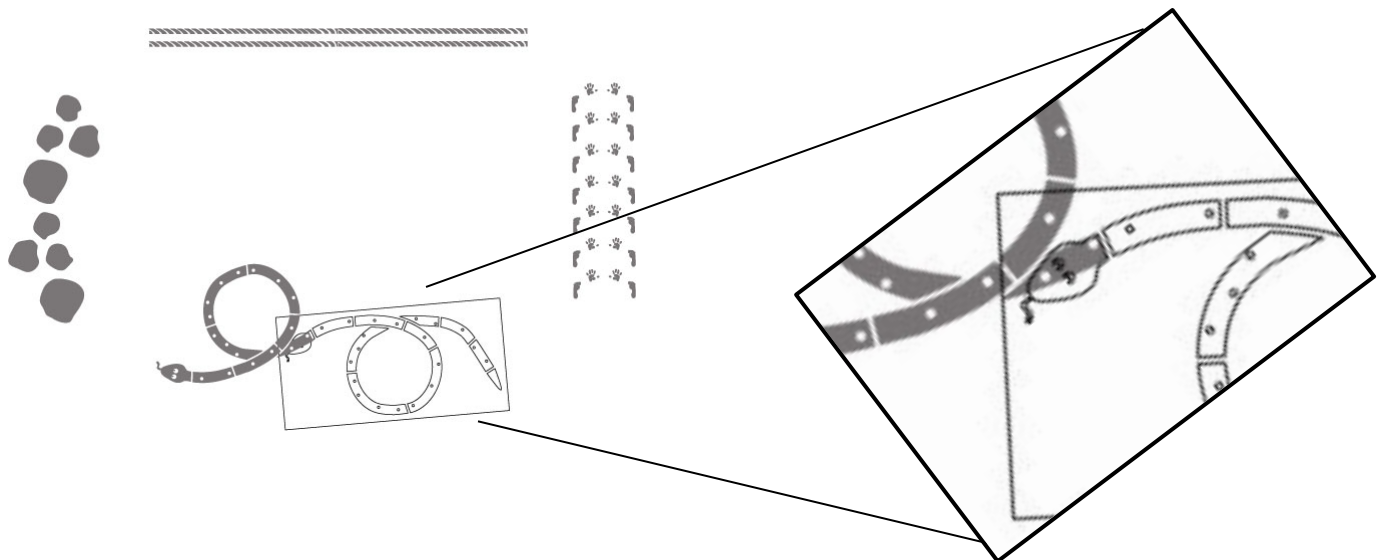

6. The painted snake should appear like below on the pavement.

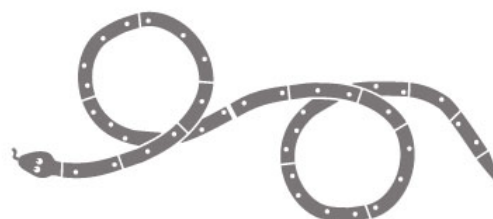

7. Take wood log stencil and place below stepping stones stencil, as shown below left. Paint, let dry and remove stencil. Once paint and stencil is dry, re-apply wood log stencil by placing it below painted wood logs on the pavement as shown below right. Paint, let dry and remove stencil.

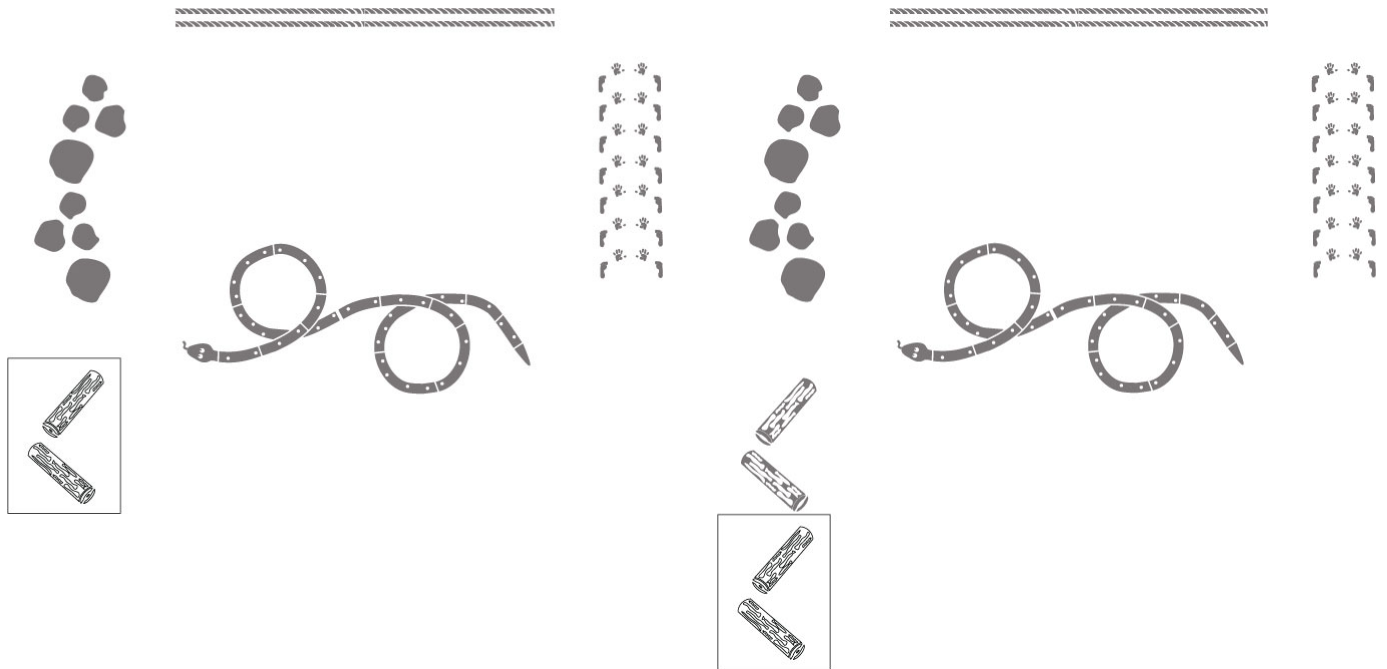

8. Take ants stencil and place below hands and feet stencil, as shown below left. Paint, let dry and remove stencil. Once paint and stencil are dry, flip ant stencil over and align as shown below right. Paint, let dry and remove stencil.

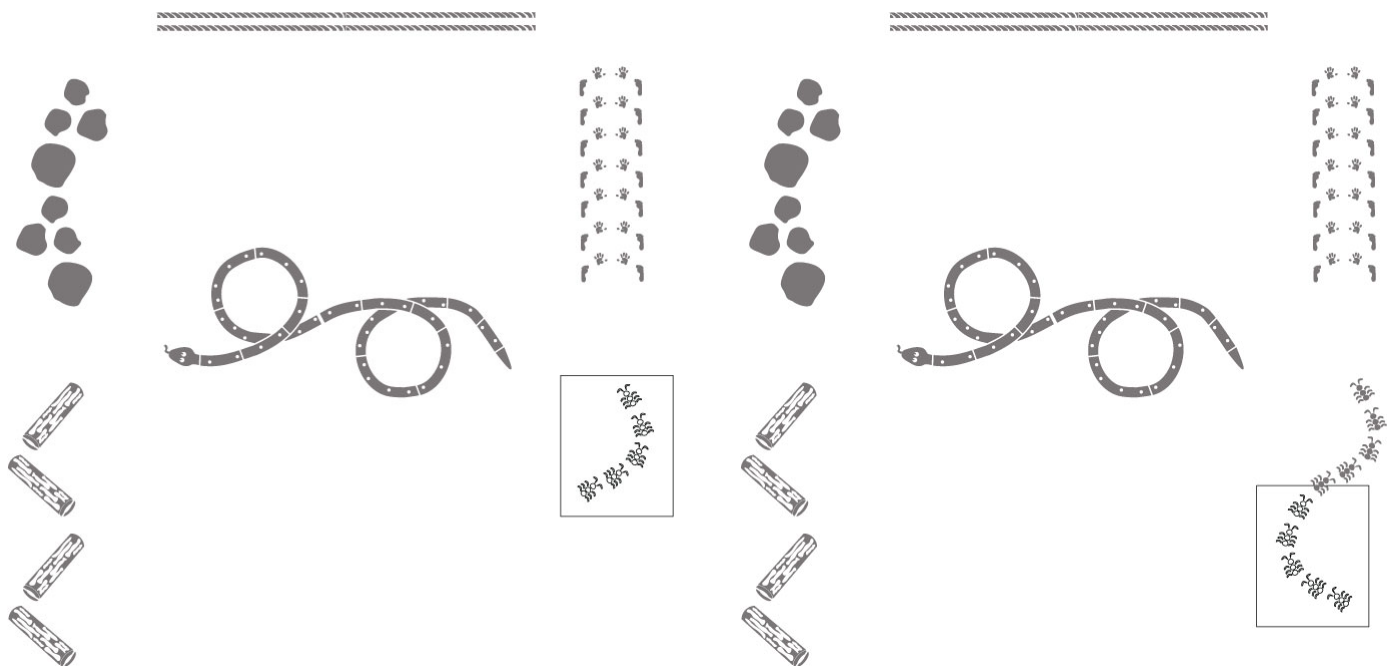

9. Take rope stencil again and place to the right of end of painted logs, as shown below left. Paint, let dry and remove stencil. Once paint and stencil are dry, re-align rope stencil as shown below right. Paint, let dry and remove stencil.

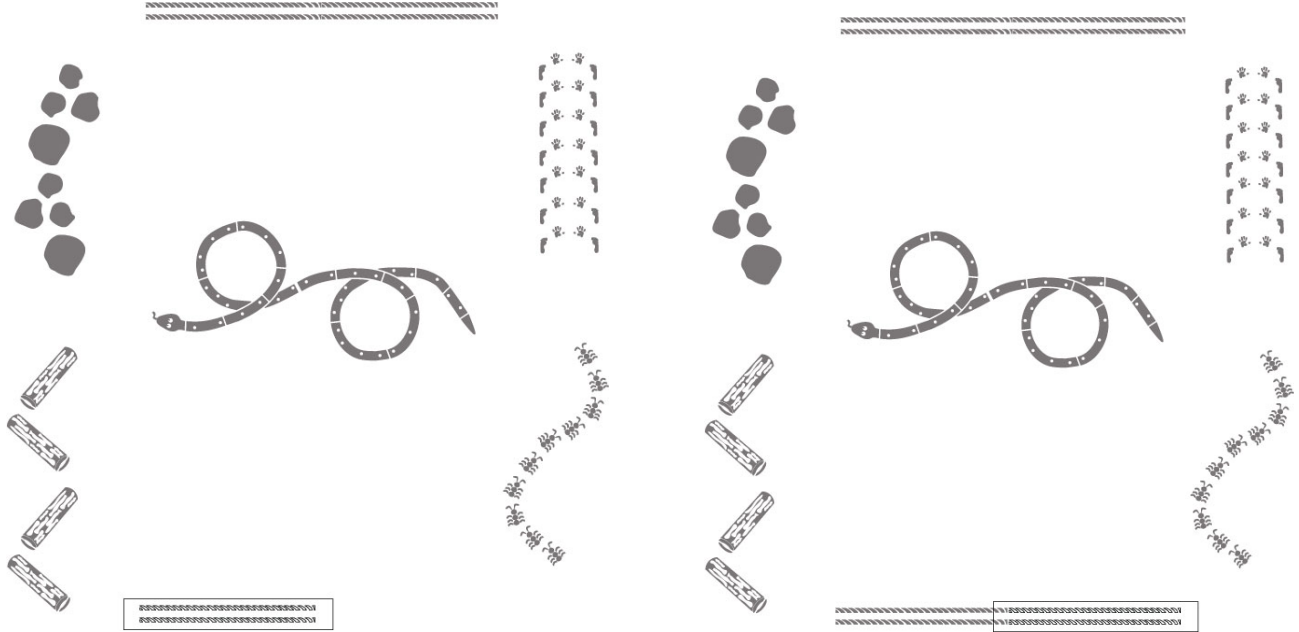

10. Take the word stencils and align as shown below left. Paint, let dry and remove stencils. The layout is complete as shown below right.

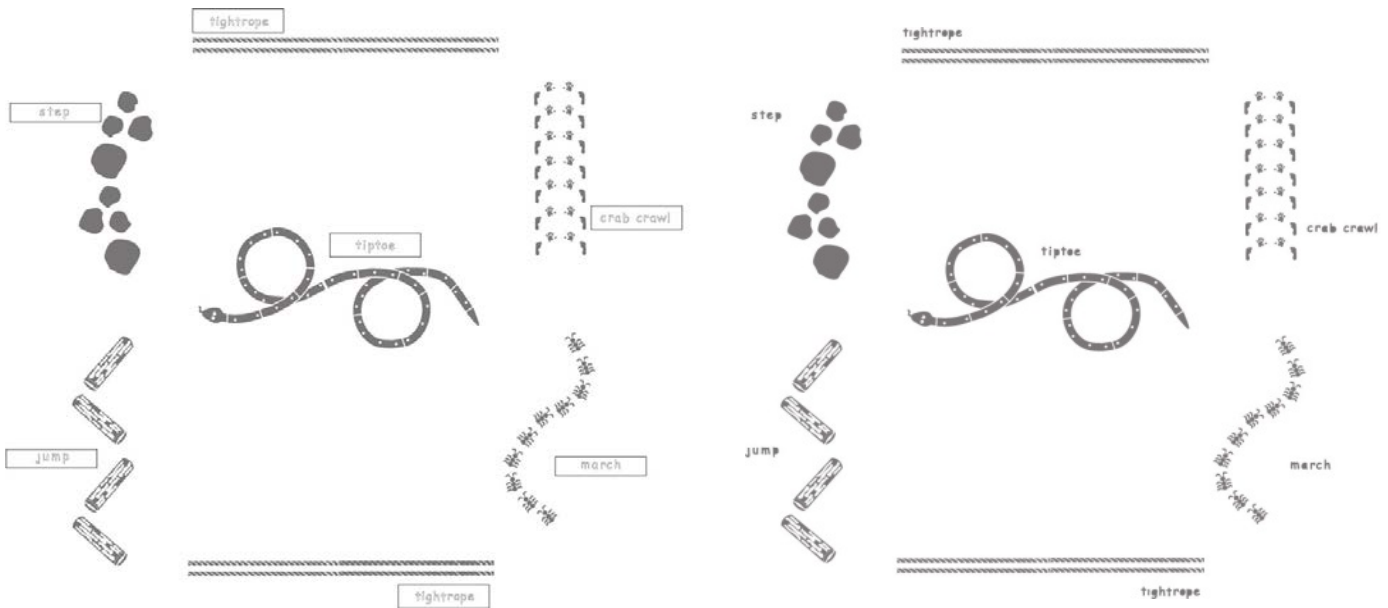

11. Allow to completely dry for at least 24 hours before use.

Any questions? We're here to help – call us at (800) 681-0684!

THIS INFORMATION IS COPYRIGHT MATERIAL. ALL RIGHTS ARE RESERVED



APPLICATION INSTRUCTIONS

FOR THE

DAISY HOPSCOTCH

Product Number: 12-2W-03

SIZE: approximately 14 feet high x 4 feet wide.

ESTIMATED PAINT TIME: approximately 1 – 2 people for 1 – 2 hours.

FIRST READ: Completely read "General Instructions". Prepare surfaces as recommended before painting.

1. Place STENCIL A in desired location. Either paint STENCIL A and then align STENCIL B or align STENCIL B under STENCIL A as shown below and then paint. Using chalk, mark the alignment holes on each side of the flower circle "head" from STENCIL A.

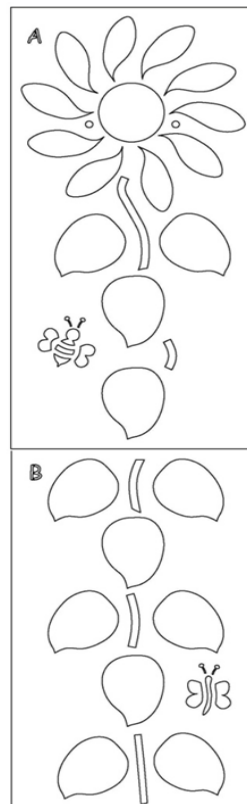

- Repeat 1-2 more times to achieve desired vividness, drying after each application, and remove STENCIL A and B. It should look like this:

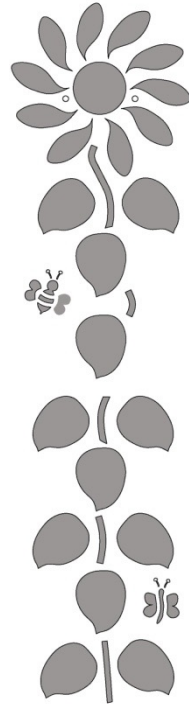

- After completely drying, place and align the numbered cutouts within spaces starting with "1" at bottom left. Paint as desired with thin brush. Let dry. Repeat 1-2 more times to achieve desired vividness, drying after each application.

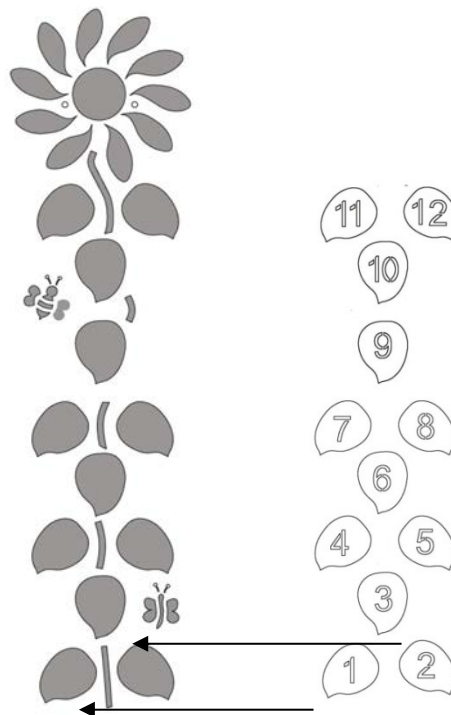

4. Once completely dry, remove numbered cut outs. The stencil should look as follows:

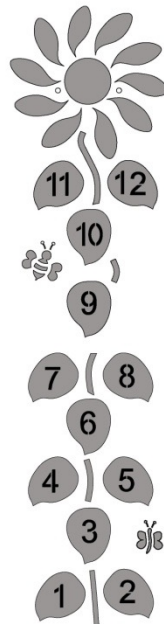

5. Take the sheet with the sunglasses and mouth, as shown to bottom right, and match to the chalked alignment holes on the pavement. Check and adjust to fit within circle.

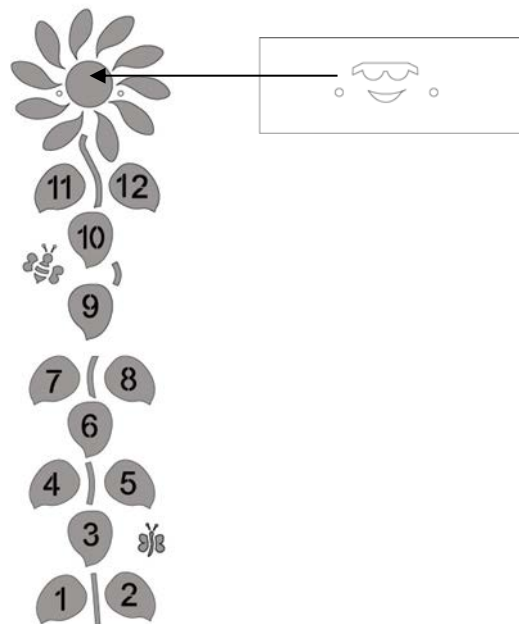

6. Paint as desired with thin brushes. Let dry. Repeat 1-2 more times to achieve desired vividness, drying after each application. Allow all paint to dry for a minimum of 24 hours. It should look like this when done:

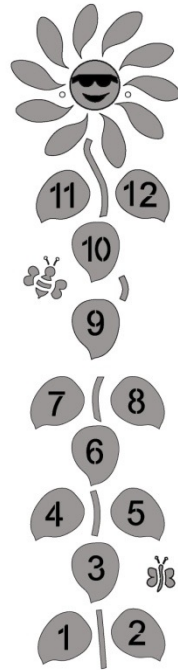

Any questions? We're here to help – call us at (800) 681-0684!



THIS INFORMATION IS COPYRIGHT MATERIAL. ALL RIGHTS ARE RESERVED.
© 2017 FIT AND FUN PLAYSCAPES, LLC